

## HD Rail Installation Guide

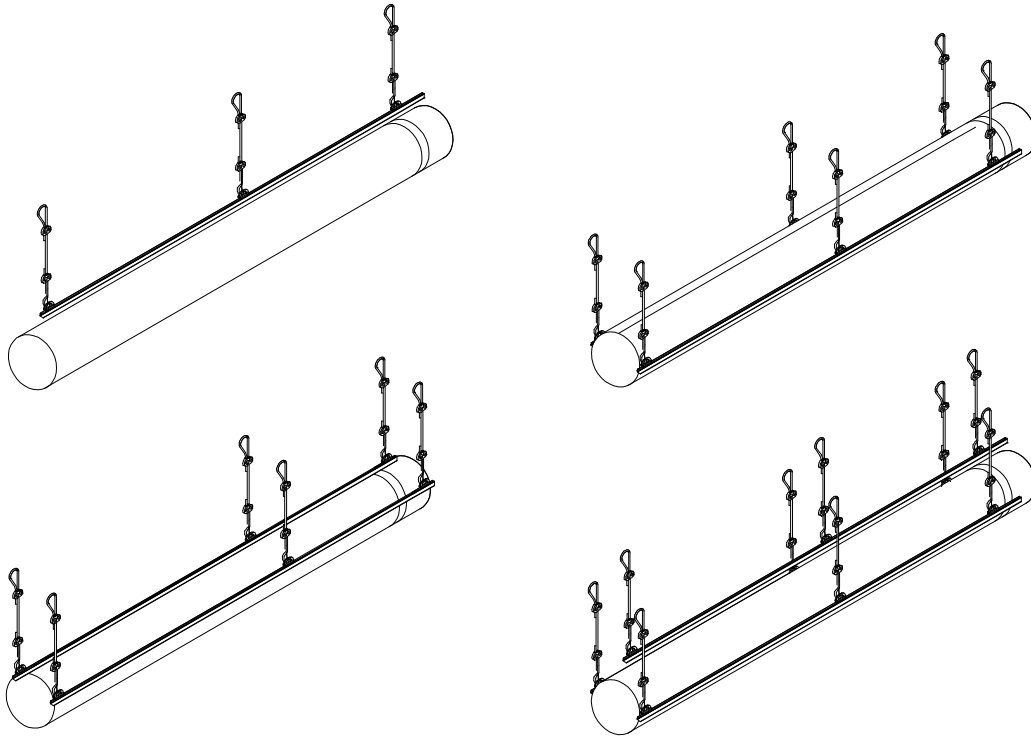

### INSTALLATION INSTRUCTIONS OVERVIEW

**STEP ONE: INVENTORY**

**STEP TWO: SUSPENSION HARDWARE**

**A) SINGLE SUSPENSION**

**B) DOUBLE SUSPENSION**

**STEP THREE: INSTALLATION OF FABRIC DIFFUSER**

**STEP FOUR: START UP**

**WARRANTY**

**CLEANING AND REPAIR**

#### STEP ONE: INVENTORY

Before installing fabric diffuser system read all general information in the following sections. For best results use this manual in conjunction with the mechanical blue print or diffuser layout if supplied.

Check the shipment carefully. Diffuser systems are shipped in polyethylene bags or boxes. Larger orders will be shipped in large skidded containers with individual contents in polyethylene bags or folded. All packages will be labeled with diffuser diameter and length.

Make sure contents match the packing list. Note any missing or damaged pieces and notify your supplier before starting installation. Check length & diameters before installing & contact supplier before installation. (Not responsible for labor costs accrued from installing incorrect lengths or layouts.)

## STEP TWO: SUSPENSION HARDWARE

The aluminum rail supplied comes in 10 foot sections. The orientation ( 12 o, clock ) suspension should be 3" from the diffuser to where the vertical cable, (Speed Link), connects to the rail support bracket. Rail must be aligned with the centerline of the air flow. Determine the height of the rail. Rail must be supported level in order for the components to assemble properly. Start from the air handler end of system and support rails with speed links from rail support up to bar joist, eyebolts, beam clamps, etc. Because applications differ, what the cable can be anchored to is up to the installer. The supports slide into the top opening of the rail. It is recommended to use 2 supports per 10 foot rail. Support the next rail and connect it to the previous with the rail couplers. Rail couplers slip into the center of each end of the rails. Slip Coupler in first rail and secure with zip screw in side of rail. Then slide next rail over coupler and bump end flush with first rail and secure with zip screw. Repeat this process until done.

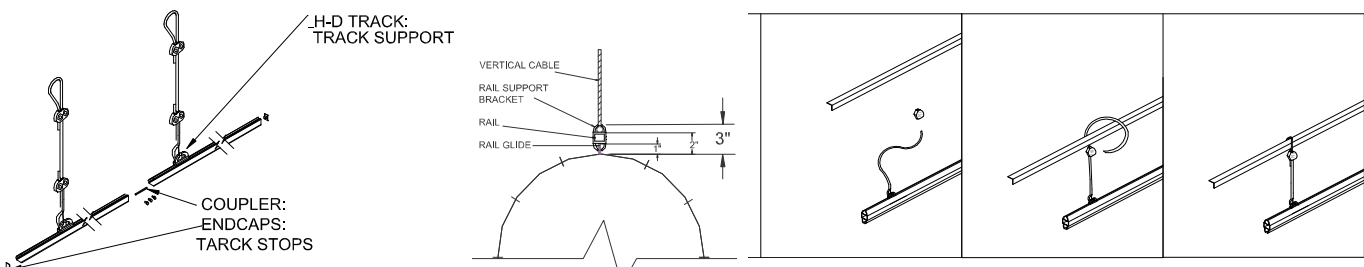

When fabric fittings are incorporated in your installation, align rails with the centerline of the system. All rails must be installed at the same elevation.

When elbows are used in the system rail should be installed as indicated as above. Rail bends and precut rail sections will be provided for suspension of the elbows. (Note: rail bends may come in two sections, a coupler may be needed to connect.)

When tee's or take offs are used install rails as above. Install rail perpendicular to main rail to suspend branch runs. To insure proper alignment the main of the fabric system can be installed to the rail and the air handler first. Then the cross rails perpendicular to the main can be installed to suspend the branch runs.

If the take off port is top even all glides will be the same distance of the diffuser. If the take off port is centered on the side of the main, the glides are normally extended the same level as the glides of the main duct. Fittings may have quick connect joints such as zippers to ease the installation and maintenance of the system.

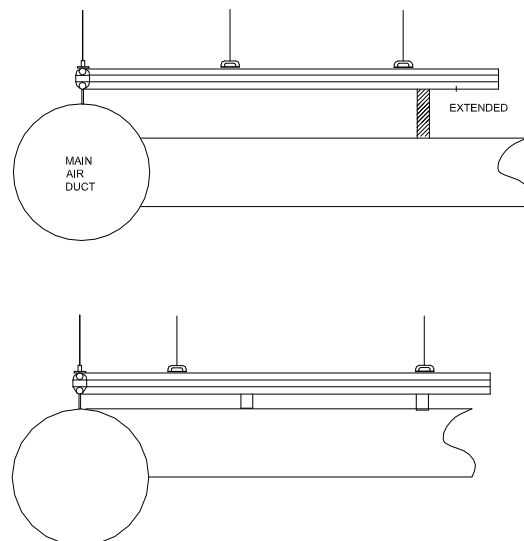
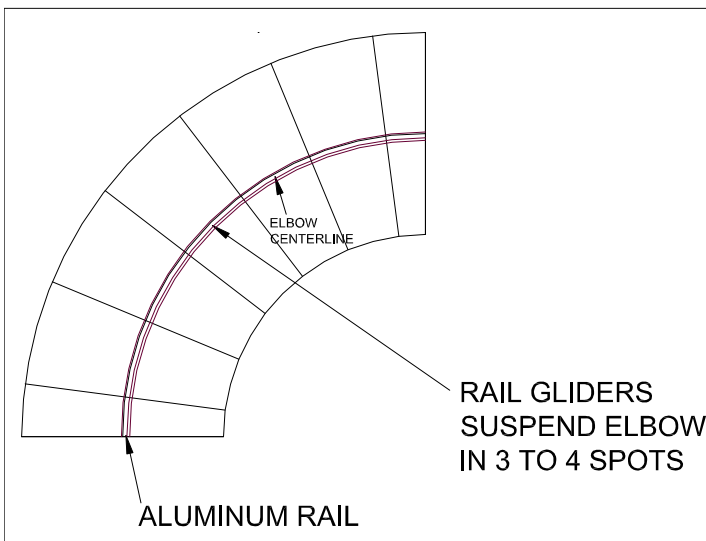

## B) DOUBLE RAIL SUSPENSION

When installing a two rail suspension system, it is important to review the diffuser layout. It is important to notice location of elbows, tees, or reductions. Improper placement of the rail may cause wear on the fabric.

Double rail installation are similar to single rail suspension systems. There are different variations of double rail systems. Refer to the diagrams below. Glides can be extended so that all rails will be at the same elevation. Fittings may have quick connect joints such as zippers to ease the installation and maintenance of the system.

NOTE: 6:00 & 12:00 suspension is similar to 12:00 suspension with rail to rail distance =  $(\text{DIA.} + 6")$ . 3 point suspension combine single suspension with one of the 2 point suspensions below.

**3:00 & 9:00**

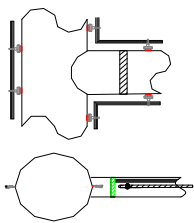
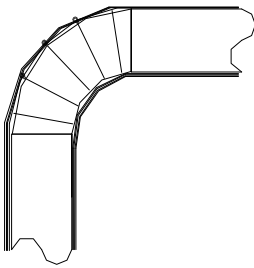
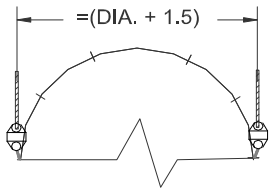

**3:00 & 9:00 EXTENDED**

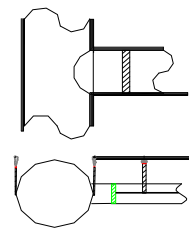
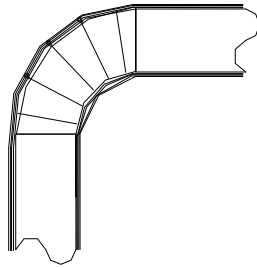
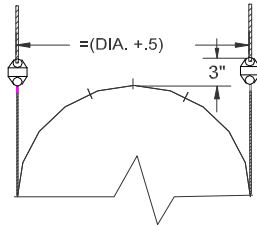

**2:00 & 10:00**

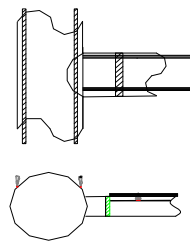
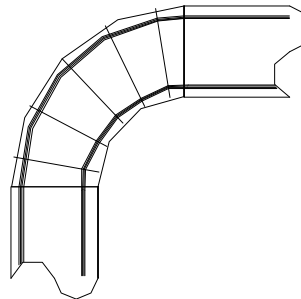
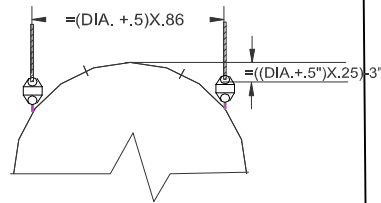

**2:00 & 10:00 EXTENDED**

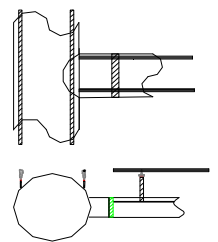
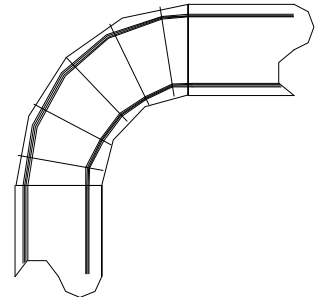
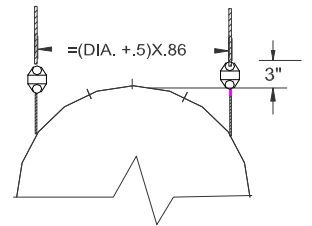

Note: The previous drawings illustrate possible double rail suspension systems. Since every installation is different, support brackets are not supplied. Triple suspension systems used on larger diameters systems

### **STEP THREE: INSTALLATION OF FABRIC DIFFUSER**

When handling a diffuser prior and during installation, please keep anything that comes in contact with the diffuser clean. If a diffuser is to be laid out on the floor, make sure floor is clean or something is laid down to protect diffuser from dirt or debris on the ground that could catch on air jets and damage diffuser during installation.

- 1.) Slide the gliders down through the rail.
- 2.) Pull diffuser down the rail until fully extended.
- 3.) Pull open end of diffuser and slip over metal collar or metal duct (about 6-12").
- 4.) install worm gear band around diffuser to secure it to metal duct.

Note: Worm gear bands are perforated and self tapping screws can be used to help secure band and keep from slipping. ( screws not included).

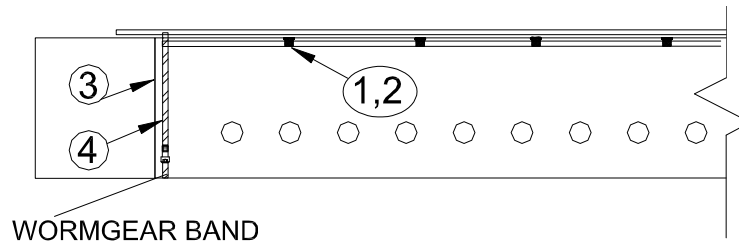

### **STEP FOUR: START UP**

Turn on air handler and inflate diffuser. With the diffuser inflated, anchor the last glider of the diffuser near to the rail by drilling a set screw before it as shown. This will keep the diffuser fully extended when diffuser is deflated and keep the diffuser from sliding back.

If the diffuser system flutters after installation, check to see if air handler is operating at its designed air volume and static pressure. Fluttering can cause damage to fabric shortening life of system.

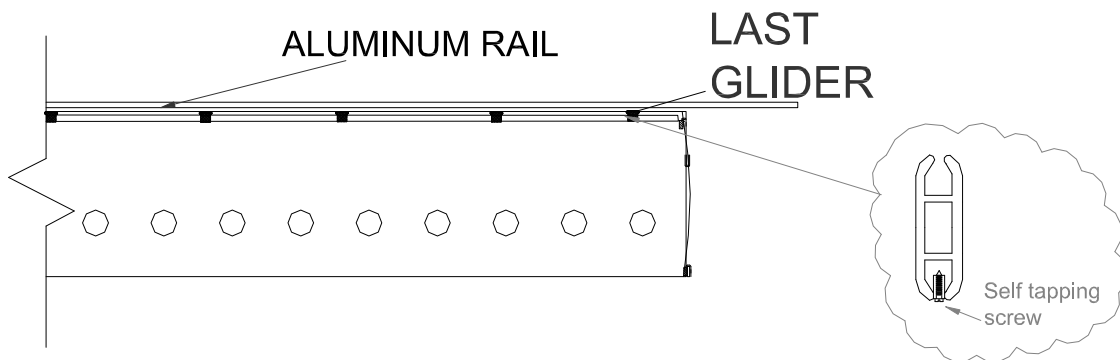

### **WARRANTY INFORMATION**

Diffuser systems are subject to a five year limited warranty. The warranty covers workmanship and materials on all components of the system. Only replacement costs and credits are covered. Cash payments are not available. The warranty covers freight costs, but does not cover installation costs. The warranty excludes damage caused by improper installation, failure to specify all system requirements and air handling equipment not performing as specified.

The effective start date of the warranty is the product ship date.